

2SC2712 TRANSISTOR (NPN)

FEATURE

- Audio Frequency General Purpose Amplifier Applications
- Low Noise: NF=1 dB (Typ),10dB(MAX)
- Complementary to 2SA1162

SOT-23

1. BASE
2. EMITTER
3. COLLECTOR

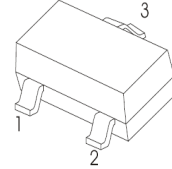

MAXIMUM RATINGS (T_a=25°C unless otherwise noted)

Symbol	Parameter	Value	Unit
V _{CB0}	Collector-Base Voltage	60	V
V _{CEO}	Collector-Emitter Voltage	50	V
V _{EBO}	Emitter-Base Voltage	5	V
I _C	Collector Current -Continuous	150	mA
P _C	Collector Power Dissipation	150	mW
T _J	Junction Temperature	150	°C
T _{stg}	Storage Temperature	-55-150	°C

ELECTRICAL CHARACTERISTICS (T_a=25°C unless otherwise specified)

Parameter	Symbol	Test conditions	Min	Typ	Max	Unit
Collector-base breakdown voltage	V _{(BR)CBO}	I _C = 100μA, I _E =0	60			V
Collector-emitter breakdown voltage	V _{(BR)CEO}	I _C =1mA, I _B =0	50			V
Emitter-base breakdown voltage	V _{(BR)EBO}	I _E = 100μA, I _C =0	5			V
Collector cut-off current	I _{CB0}	V _{CB} = 60 V, I _E =0			0.1	μA
Emitter cut-off current	I _{EBO}	V _{EB} =5V, I _C =0			0.1	μA
DC current gain	h _{FE}	V _{CE} =6V, I _C =2mA	70		700	
Collector-emitter saturation voltage	V _{CE(sat)}	I _C = 100mA, I _B =10mA		0.1	0.25	V
Transition frequency	f _T	V _{CE} =10V, I _C = 1mA	80			MHz
Output capacitance	C _{ob}	V _{CB} =10V, I _E =0, f=1 MHz		2.0	3.5	pF
Noise Figure	NF	V _{CE} =6V, I _C =0.1mA, f=1kHz, R _g =10kΩ		1.0	10	dB

CLASSIFICATION OF h_{FE}

Rank	O	Y	GR	BL
Range	70-140	120-240	200-400	350-700

Typical Characteristics

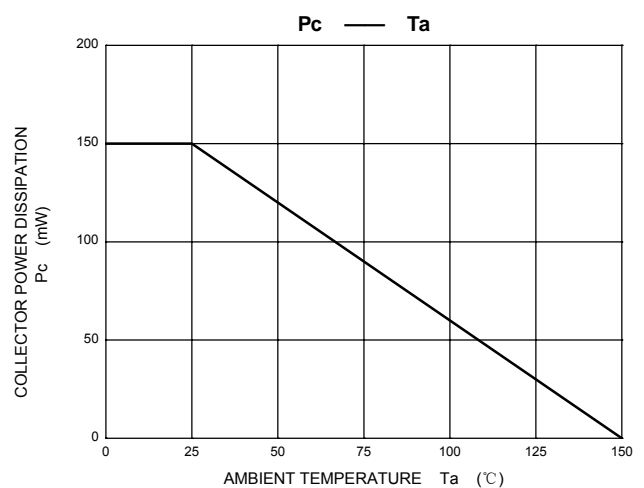
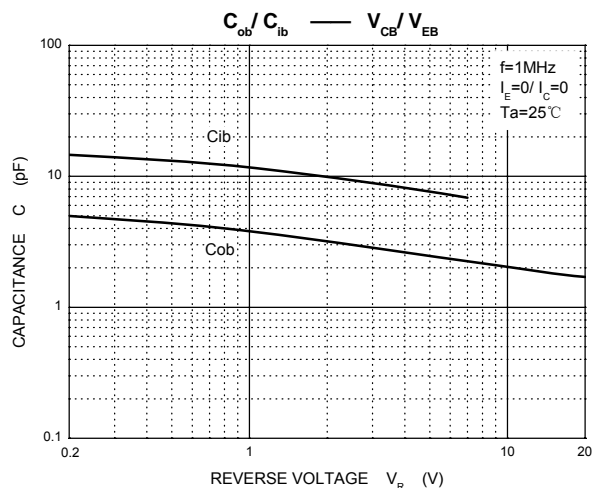
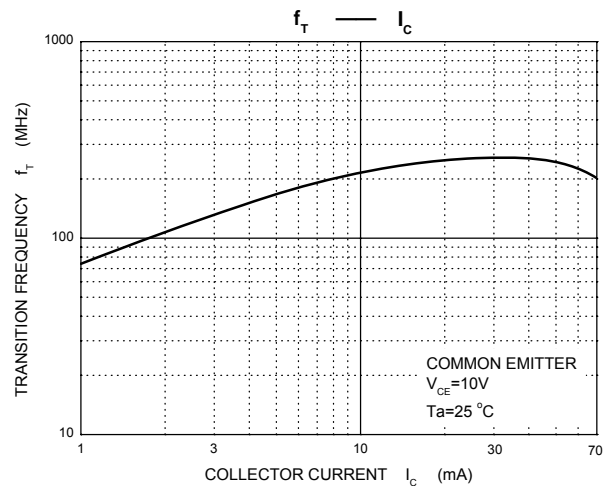
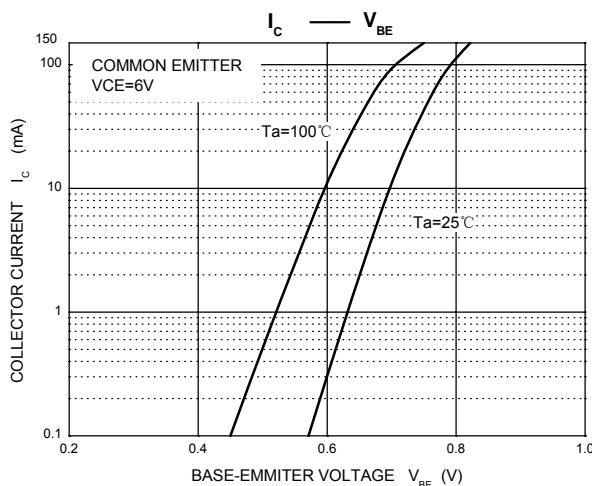
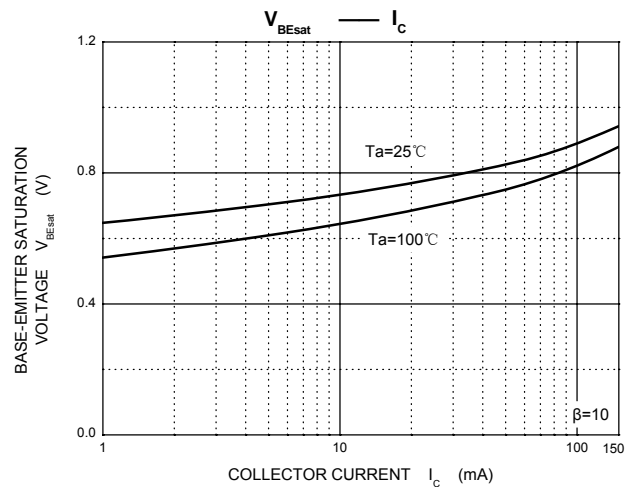
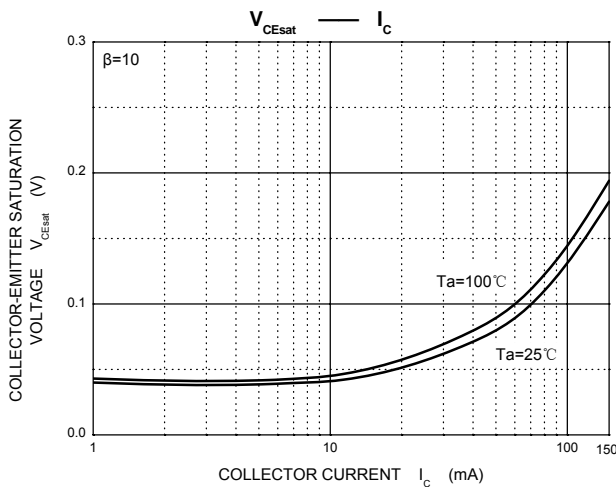
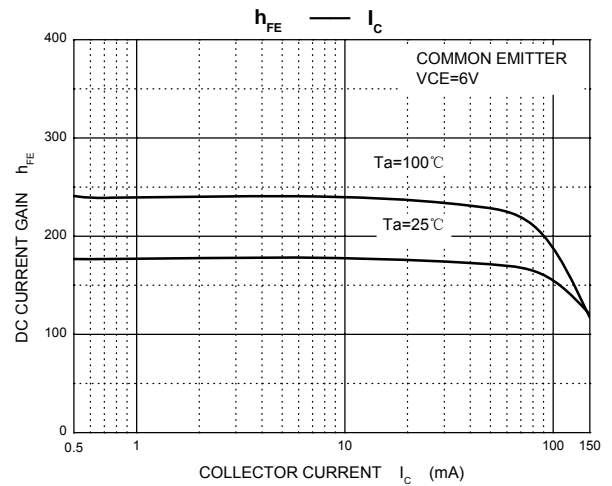
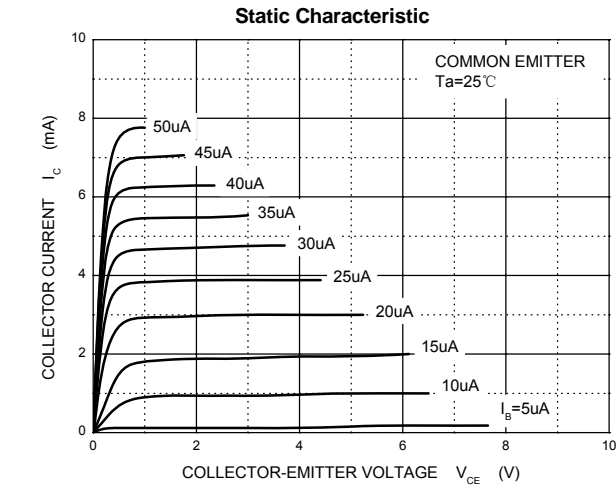

PACKAGE OUTLINE

Plastic surface mounted package

SOT-23

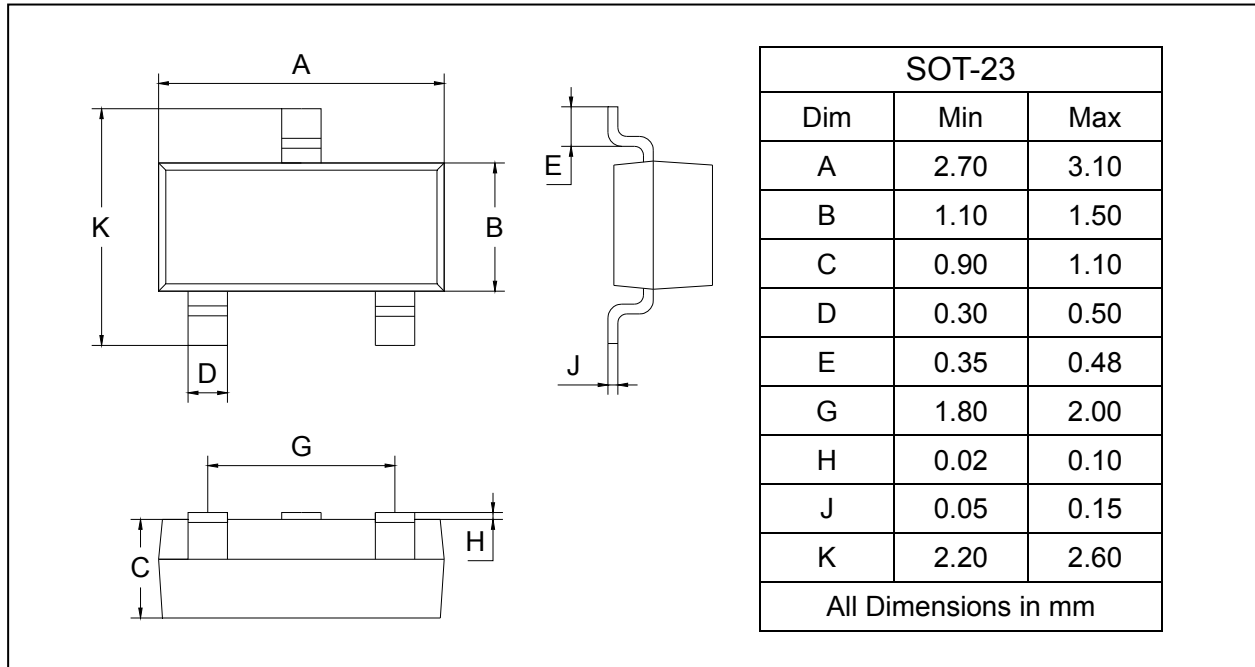

SOLDERING FOOTPRINT

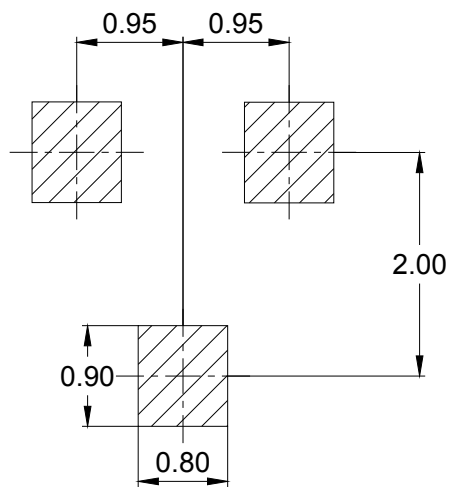

Unit: mm

SOT-23 Embossed Carrier Tape

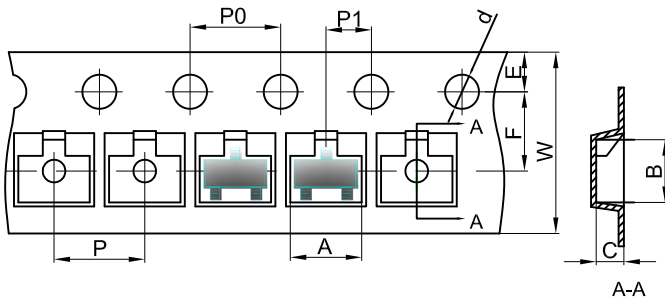

Packaging Description:

SOT-23 parts are shipped in tape. The carrier tape is made from a dissipative (carbon filled) polycarbonate resin. The cover tape is a multilayer film (Heat Activated Adhesive in nature) primarily composed of polyester film, adhesive layer, sealant, and anti-static sprayed agent. These reeled parts in standard option are shipped with 3,000 units per 7" or 17.8cm diameter reel. The reels are clear in color and is made of polystyrene plastic (anti-static coated).

Dimensions are in millimeter										
Pkg type	A	B	C	d	E	F	P0	P	P1	W
SOT-23	3.15	2.77	1.22	Ø1.50	1.75	3.50	4.00	4.00	2.00	8.00

SOT-23 Tape Leader and Trailer

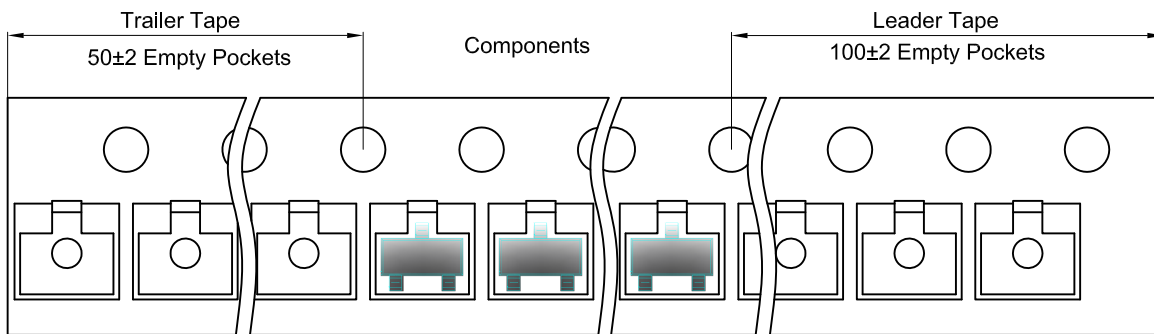

SOT-23 Reel

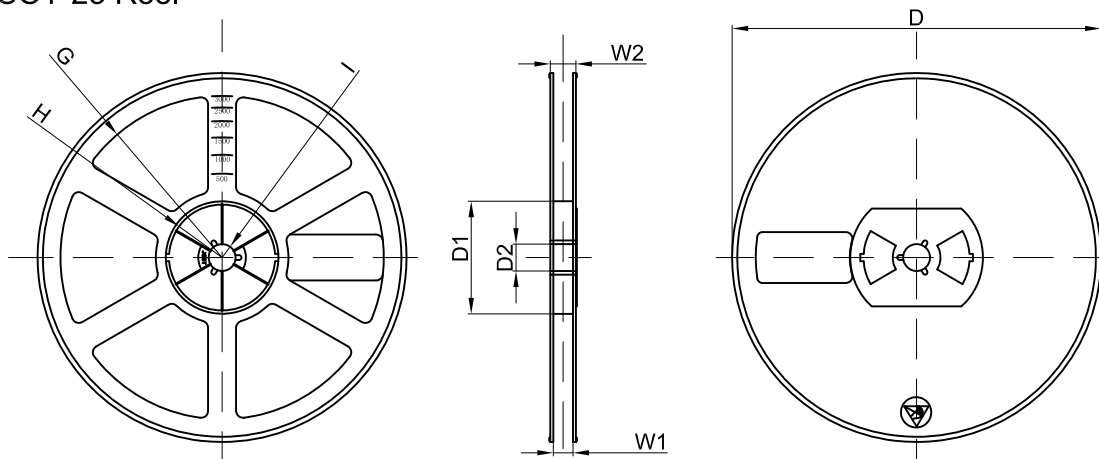

Dimensions are in millimeter								
Reel Option	D	D1	D2	G	H	I	W1	W2
7"Dia	Ø178.00	54.40	13.00	R78.00	R25.60	R6.50	9.50	12.30

REEL	Reel Size	Box	Box Size(mm)	Carton	Carton Size(mm)	G.W.(kg)
3000 pcs	7 inch	45,000 pcs	203×203×195	180,000 pcs	438×438×220	